

**Fos 12** code: 01.A.012

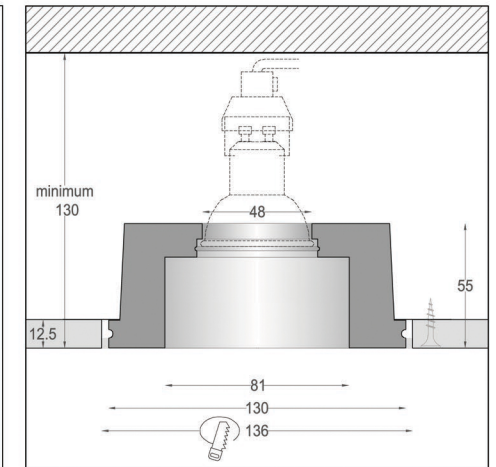
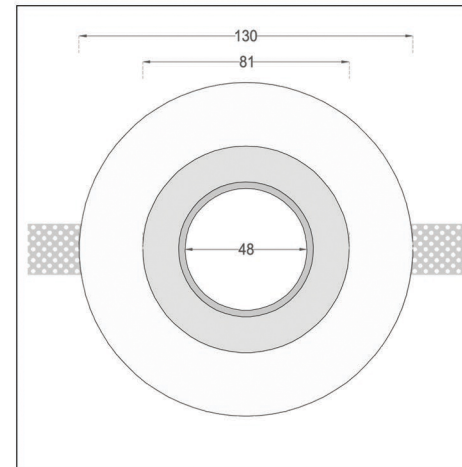

ceiling 

**Recessed Downlight**  
**Fos 12** code: 01.A.012

**Finishes**  
Natural Plaster Finish

 **Dimensions / Weight**  
D130x55mm / 460gr/pc

**Lamp Holder**  
GU10

**Lamp type / Max consumption / Voltage**  
MR16 Led or Halogen / 50Watt / 220-240V  
note: This recessed downlight can also be used with GU 5.3 / MR16 / 12V

**Features**

